

Round Metal Project Rail Shower

Nero

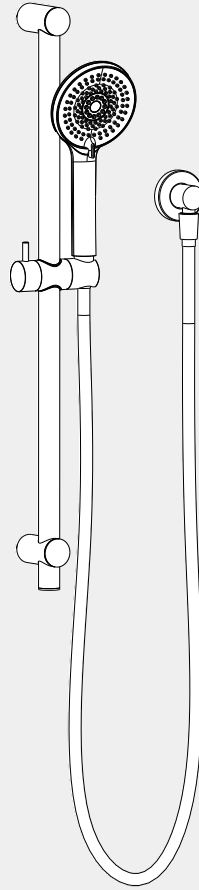

Versions:202311

Drawing

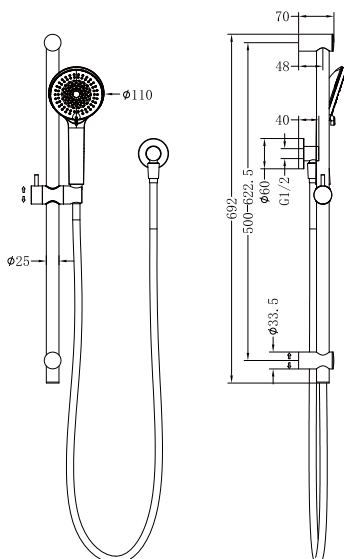

Specifications

SKU

NR318

Watermark License

WM-060093

Temperature Rating

Min 1°C - Max 75°C

Pressure Rating

Min 150kpa - Max 500kpa

Finish

Chrome
NR318CH

Gun Metal
NR318GM

Brushed Nickel
NR318BN



Matte Black
NR318MB

Brushed Gold
NR318BG

Packaging Includes

- 1x Handle Shower (Built-In Check Valve)
- 1x Shower Hose
- 1x Elbow
- 1x Shower Rail

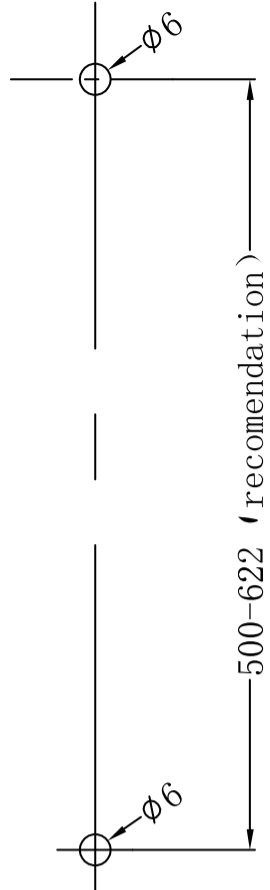
*Dimensions are nominal measurements only.

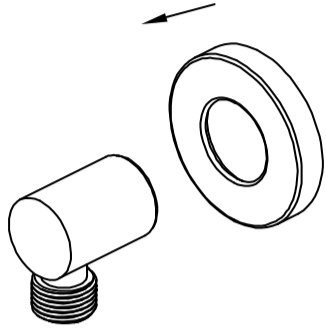
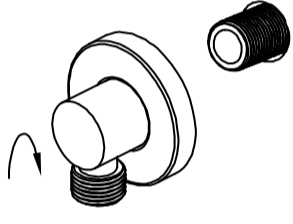
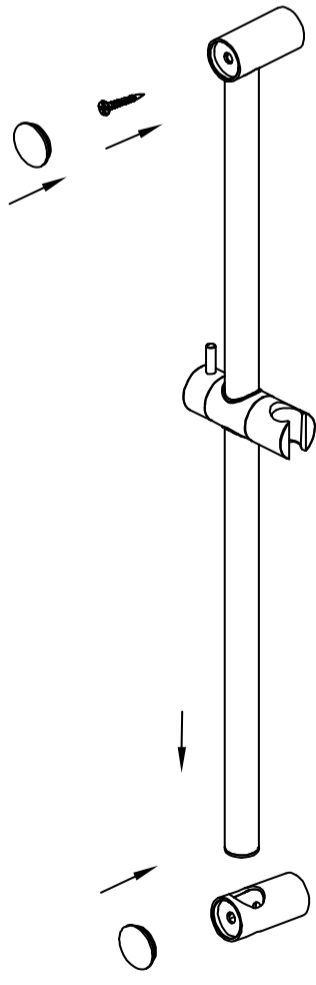
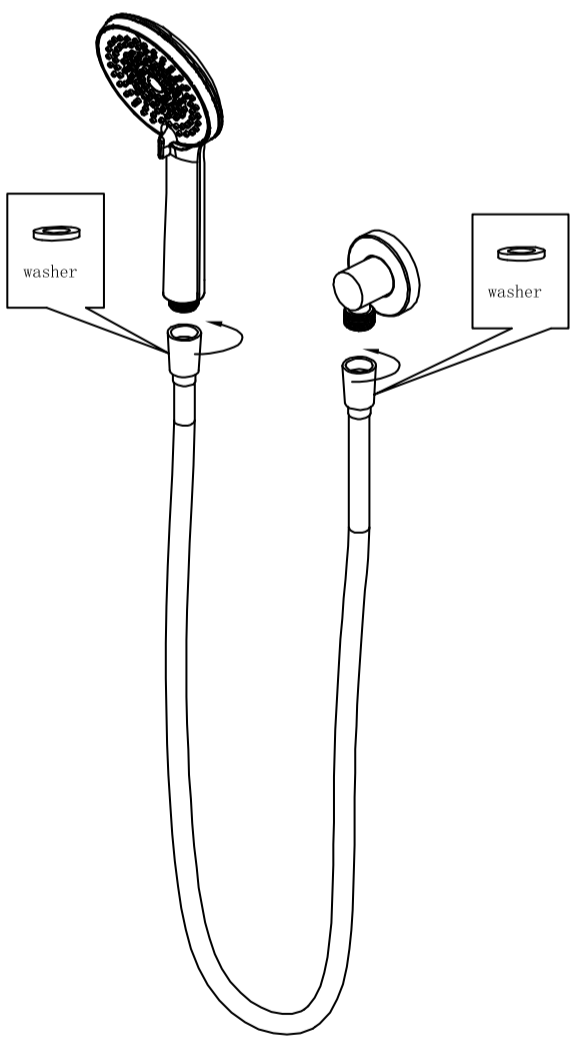
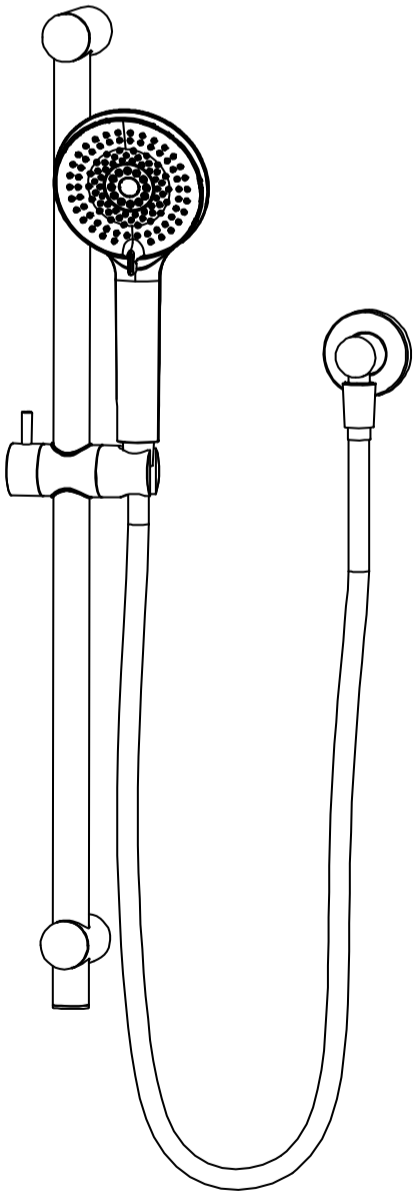
<p>use Teflon tape</p>  <p>1. Put Teflon tape on outlet thread.</p>	 <p>4. Drill two $\phi 6$mm holes according to above picture.</p>	  <p>5. Mount bottom bracket on the $\phi 6$ hole by expansion plug and tapping screw.</p>	
 <p>2. Pull dressing ring on the elbow body.</p>		<p>4. Drill two $\phi 6$mm holes according to above picture.</p>	<p>5. Mount bottom bracket on the $\phi 6$ hole by expansion plug and tapping screw.</p>
 <p>3. Screw elbow body on to outlet.</p>			
 <p>6. Plug shower rail in bottom bracket. Mount top bracket on the top hole by expansion plug and tapping screw. Push plates onto two brackets.</p>	 <p>7. Connect hand shower with outlet by shower hose</p>	 <p>8. Test for leaks.</p>	

Nero

info@nerotapware.com.au
nerotapware.com.au

11-13 Buontempo Road
Carrum Downs Vic 3201

