

Mecca Care 25mm Toilet Roll Rail 300/450mm

Nero

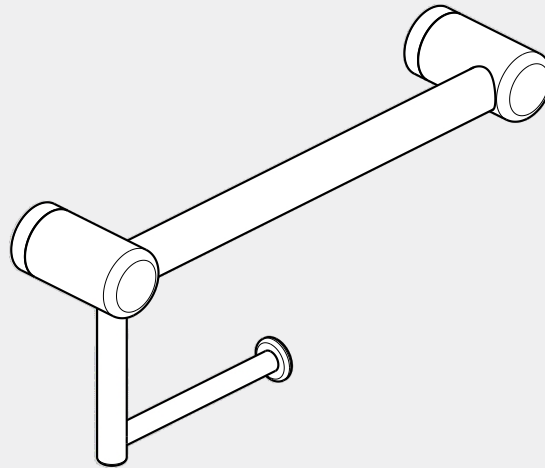

Versions:202311

Drawing

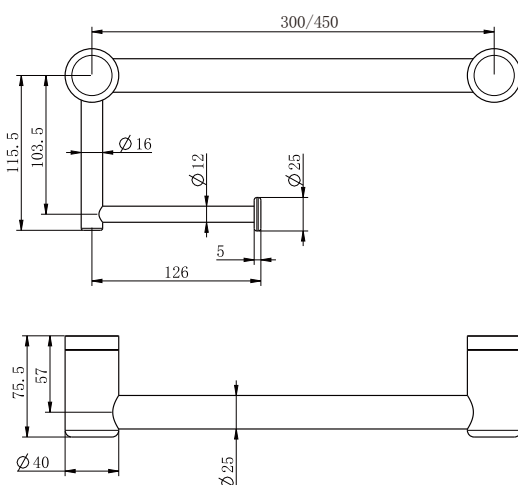

Specifications

SKU







300mm Length:NR2512a

450mm Length:NR2518a

Warning:

These rails are designed to be mounted onto wall studs or masonry walls. Installation is recommended to be completed by qualified trades person who complies with the AS 1428.1-2009 design for access and mobility standard. It is recommended rail location is determined by a qualified occupational therapist or trained professional to the AS 1428.1-2009 standard. Correct installation is required to ensure safe, long term operation. Incorrect mounting can result in reduced capacity of the rail which can result in injury to user and damage to the wall.

Finish



 Chrome NR2512aCH/NR2518aCH	 Gun Metal NR2512aGM/NR2518aGM	 Brushed Bronze NR2512aBZ/NR2518aBZ
 Matte Black NR2512aMB/NR2518aMB	 Brushed Gold NR2512aBG/NR2518aBG	 Brushed Nickel NR2512aBN/NR2518aBN

Features

1. Australian owned and designed.
2. The direction can be changed from left to right during installation.
3. 150 kg capacity for all 25mm and 32mm diameter grab rails.
4. 25mm diameter rails are suitable for heavy duty towel rails and smaller hands.
5. Gun metal, brushed gold and brushed bronze colours are PVD coated for long term durability.

*Dimensions are nominal measurements only.

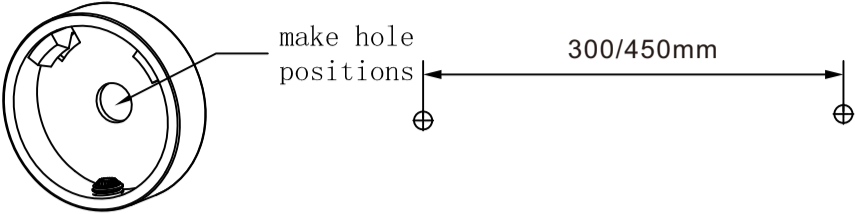
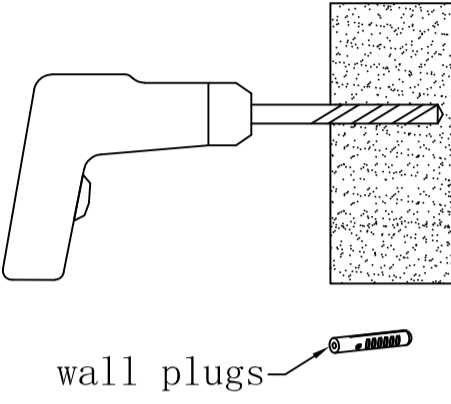
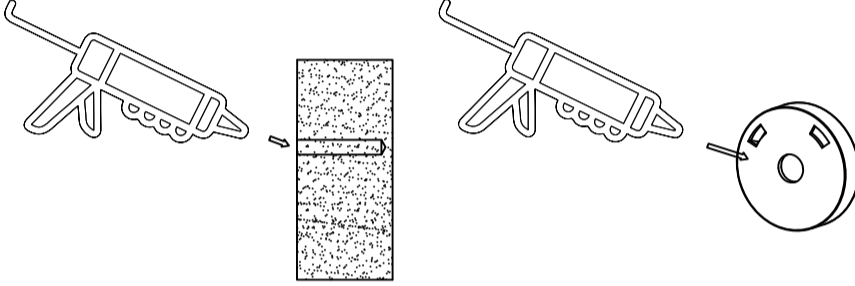
Installation Instruction

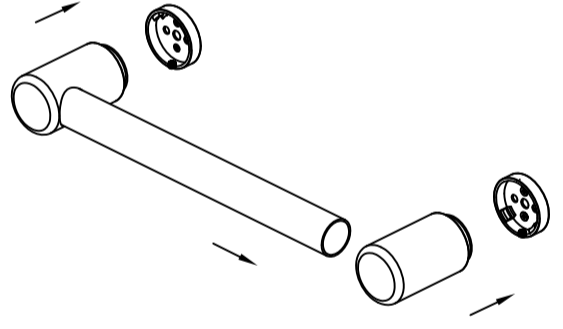
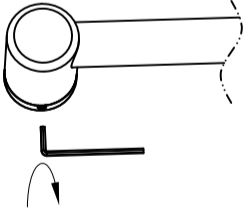
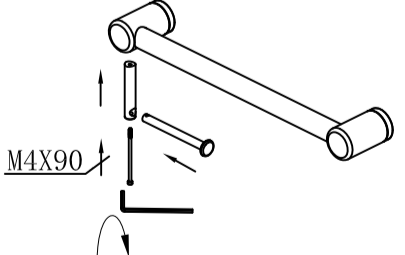
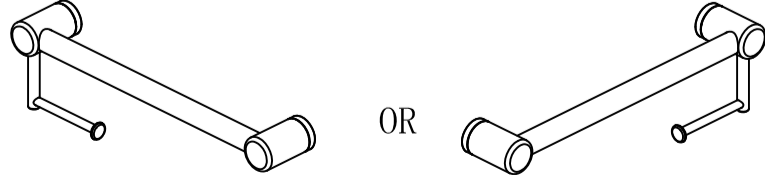
	<p>1. Locate wall studs, install into at least one stud. Place wall seal/mounting bracket on wall at correct height over centre of stud and mark hole positions on wall.</p>
	<p>2. Drill pilot holes into wall stud approximately 60mm deep to suit mounting screws (and wall plugs if required).</p> <p>Tip: 4mm hole for screws into timber or 10mm hole for wall plugs.</p>
	<p>3. Apply small amount of silicon to mounting bracket and wall in and around the screw holes.</p>
	<p>4. Install mounting brackets by screwing onto wall.</p> <p>Tip: Use appropriate mounting screws for the wall stud material, supplied screws are for timber wall studs.</p>
	<p>5. Slide rail tube into end bracket and push onto wall brackets.</p> <p>Tip: Rail length can be cut down to a smaller size, simply use an angle grinder, hacksaw or pipe cutter then deburr the end with a file or grinder and reinsert into the end bracket.</p>
	<p>6. Tighten grub screws with allen key.</p> <p>Tip: If rail rattles, loosen end bracket, twist slightly and tighten.</p>
	<p>7. Using supplied allen key whilst holding the toilet roll holder in place, screw the M4*90mm screw into the grab rail till tight.</p> <p>Tip: Left and Right hand available (Can be Installed on either side facing either direction)</p>
	<p>8. Finished.</p>

Nero

info@nerotapware.com.au
nerotapware.com.au

11-13 Buontempo Road
Carrum Downs Vic 3201



**MECCA CARE
ASSISTED LIVING 25MM**